

lzf



COLLECTION 2022

Wood touched by Light

A 2011
PREMIOS NACIONALES DE
ARTESANÍA



Premios
Nacionales
de **Innovación**
y de **Diseño**
2020

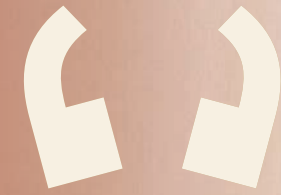



WOOD TOUCHED BY LIGHT

At LZF, we create lighting with a timeless appeal. Every one of our handmade wood veneer lamps is manufactured at home in Valencia, Spain. It has been this way since the very beginning.

Valencia is a region with an exceptional wealth of talented makers, across a breadth of creative industries. By working locally, we enjoy much greater control, freedom, and flexibility over the design and construction of our lamps.

It takes numerous hands to make a lamp: without them, we could not create, innovate, or learn. Our lamps are made with the collaboration of many people: artisans, artists, architects, designers, film-makers, lighting specialists, illustrators, photographers, and writers.

Our beautiful handmade wood veneer lamps are crafted with a combination of traditional knowledge, expert craftsmanship, technological skill, and thorough research.

At LZF, we delight in every aspect of lighting. We appreciate details, shapes, colours, and rhythms. We find beauty in imperfection. We enjoy all that surrounds us and relish the exquisite transformation that light produces in wood.

We build wood lamps in the same way that a couturier makes clothes, a jeweller fashions jewellery, and a potter throws pots: with undeniable verve and grace.

We strive to make lamps that are built to last and do not believe in obsolescence or the latest fads.

Our original lamps are made with a respect for wood, using FSC certified natural wood veneer. We treat our veneers with Timberlite®, a patented process that ensures the veneer is exceptionally pliable and resistant to wear and tear (without the need for chemicals).

Packaging is an important consideration, consideration for the natural environment and to ensure our lamps are protected during transportation. We use a combination of recycled cardboard boxes and bags made from potato starch.

HANDMADE IN SPAIN

It is now 28 years since LZF was established as a lighting brand. Today, we are a business that thrives on time-honoured craft and manufacturing techniques, complemented by modern innovation and technology. We are thrilled to work with an eclectic roster of accomplished designers and diligent craftspeople. As a collective result, LZF has received more than forty-five national and international awards, most notably Spain's Premio Nacional de Innovación y de Diseño 2020 (the National Innovation and Design Award 2020) and the Premio Nacional de Artesanía in 2011 (the Spanish National Craftsmanship Award).

As a family business, LZF is always on the side of the client and work tirelessly to meet their needs. We endeavour to provide our clients with a warm, friendly and professional level of service.

At LZF, we approach every aspect of our business with responsibility. We are not guided by trends: our collection is permanent and our handmade lamps are built to last. In a world of fast design, mass consumption and harmful waste, we value the importance of quality, know-how and local manufacturing. We believe in championing tradition in a circular economy and in promoting sustainability.

Spain is a country that is proudly dependent on its local talent and manufacturing: this is part of our nature. With increasing globalisation, we must work to regenerate the industrial fabric on which many generations of tradition have been built. LZF recognises the continual need to support our local business endeavours: we do so with complete commitment and a willingness to collaborate.

Moreover, we partner with a large number of agents, retailers, and studios across the world. We have had the privilege to share our passion for lighting with people in many countries: LZF's lamps have journeyed far and wide and are part of a showcase of great Spanish design.

LZF, proudly handmade in Spain, since 1994.



08 OMMA by Eli Gutiérrez
Suspension, Table, Floor & Wall

24 KASA by Eli Gutiérrez
Table

28 ESTELA by Mayice
Suspension

34 DUNE by Mayice
Suspension

38 SUSHI by Ray Power
Suspension

42 BIRDY by Isidro Ferrer
Life Size

50 FINISHES
Wood Shades & Metal

56 DESIGNERS
Eli Gutiérrez, Mayice, Ray Power & Isidro Ferrer

OMMA



LEAVES

OF LIGHT

Omma is an inventive lamp, like a tree with fluttering leaves full of light. In Eli Gutierrez's prepossessing design, it is almost possible to imagine the lamp's movable wood veneer, artfully edged with metal, flapping in a gentle breeze. Omma is available as a suspension lamp (with two, three and four leaves), a table lamp (with either one or two leaves), a floor lamp (with a single leaf), and a wall lamp (with a

single leaf). Individual leaves will rotate up to 180°, allowing the user to create a range of lighting moods.

The Omma family of lights are available in several wood veneer colours: Natural White, Natural Beech, and Natural Cherry. The lamp's metal finishes (used to create the spine and to edge the wood veneer modules) include: Matt Black, Matt Ivory, and Gold.



OM S2X2 BK LED 21

OMMA SUSPENSION

2 LEAVES



3 LEAVES



DOUBLE 2

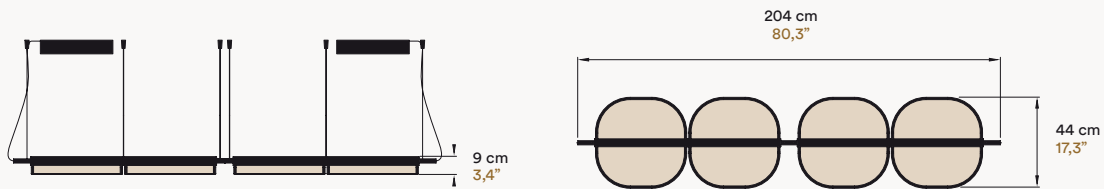

MATERIALS & COMPONENTS

Wood Veneer Shade

Metal Canopy & Structure

Coaxial Cables: 2,5 m drop 8 ft drop

Steel Cables: 2,5 m drop 8 ft drop

LIGHT SOURCE

220 - 240V

Integrated LED

Dimmable 0-10V, Bluetooth or DALI

120 - 277V

Integrated LED

Dimmable 0-10V or TRIAC

FINISHES

WOOD VENEER

23 Natural White

22 Natural Beech

21 Natural Cherry

METAL

BK-Matt Black

GD-Gold

IV-Ivory White



OM S2 GD LED 23

OMMA SUSPENSION

1 LONG LEAF

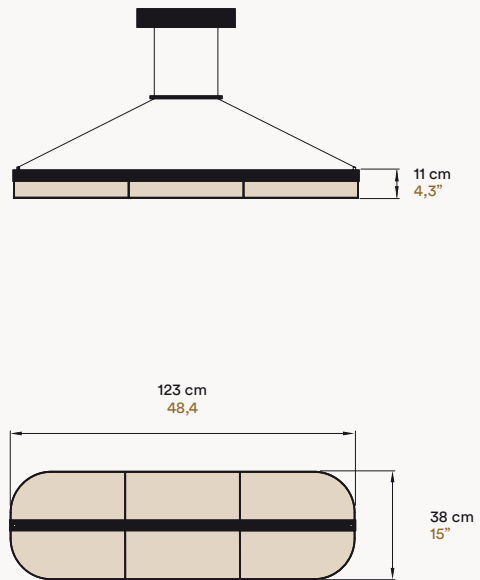

MATERIALS & COMPONENTS

Wood Veneer Shade

Metal Canopy & Structure

Coaxial Cables: 2,5 m drop 8 ft drop

LIGHT SOURCE

220 - 240V

Integrated LED

Dimmable 0-10V, Bluetooth or DALI

120 - 277V

Integrated LED

Dimmable 0-10V or TRIAC

FINISHES

WOOD VENEER

- 23 Natural White
- 22 Natural Beech
- 21 Natural Cherry

METAL

- BK-Matt Black
- GD-Gold
- IV-Ivory White



OM S120 BK LED 21



OMI MTBK LED 23



OMI M1 GD LED 23

OMMA TABLE

1 LEAF

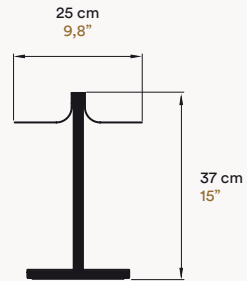
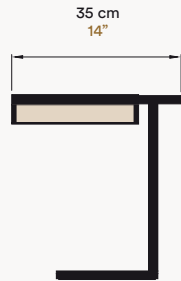

2 LEAVES

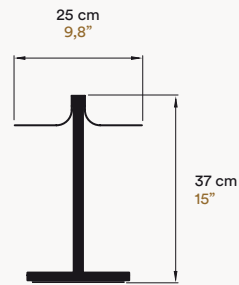
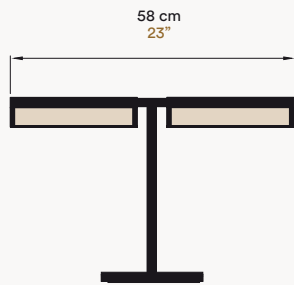

MATERIALS & COMPONENTS

Wood Veneer Shade

Metal Structure, Stem & Base

Electrical Cable with Dimming Switch 145 cm 57"

LIGHT SOURCE

220 - 240V
Integrated LED Dimmable

120V
Integrated LED Dimmable

FINISHES

WOOD VENEER

- 23 Natural White
- 22 Natural Beech
- 21 Natural Cherry

METAL

- BK-Matt Black
- GD-Gold
- IV-Ivory White



OM M2 GD LED 21



OMP GD LED 23

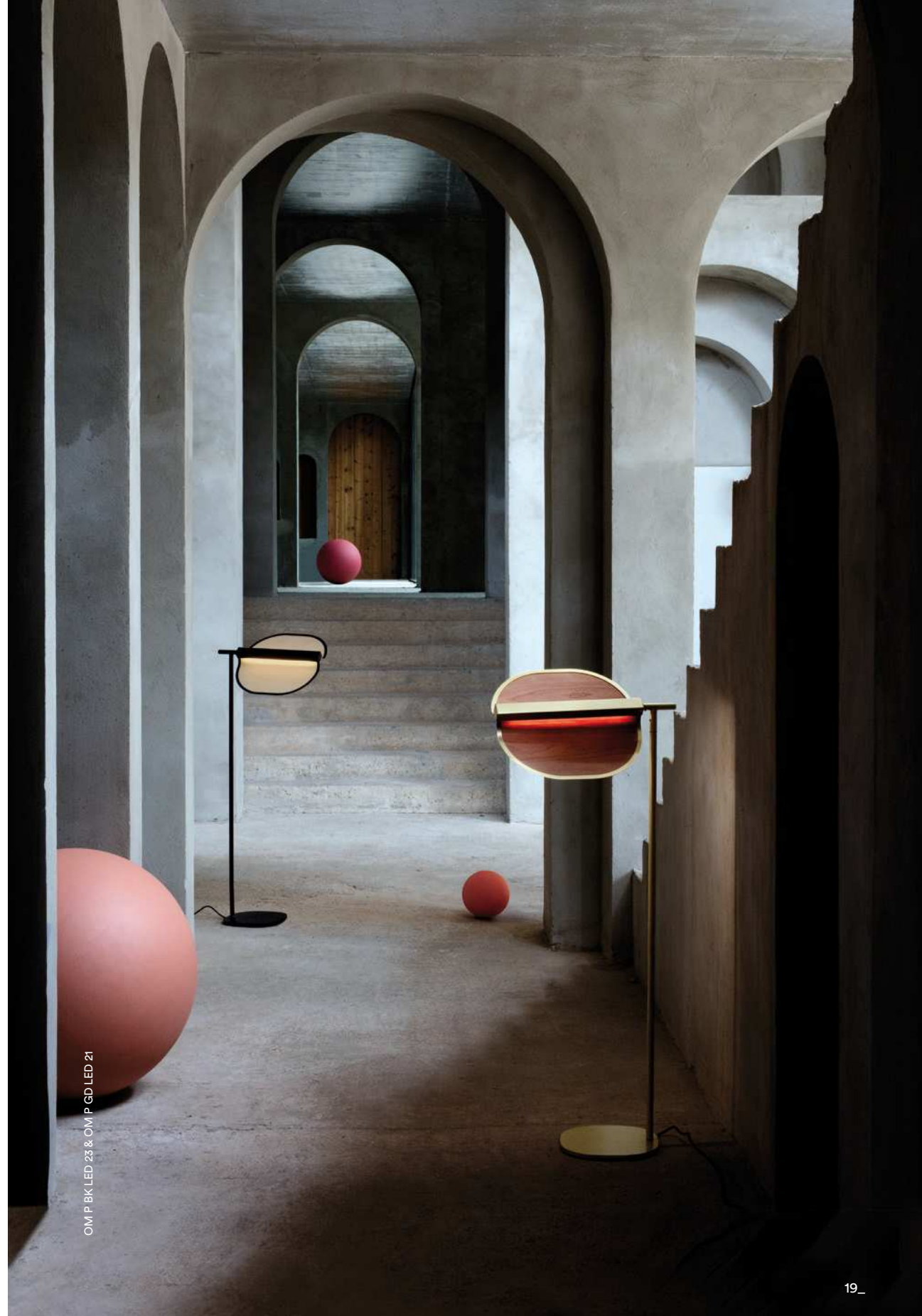

OMP P BK LED 23 & OMP P GD LED 21

OMMA FLOOR



MATERIALS & COMPONENTS

Wood Veneer Shade

Metal Structure, Stem & Base

Electrical Cable with Dimming Switch 185 cm 53"

LIGHT SOURCE

220 - 240V
Integrated LED Dimmable

120V
Integrated LED Dimmable

FINISHES

WOOD VENEER

- 23 Natural White
- 22 Natural Beech
- 21 Natural Cherry

METAL

- BK-Matt Black
- GD-Gold
- IV-Ivory White



OM P BK LED 23

OMMA WALL

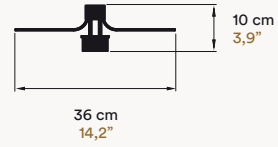
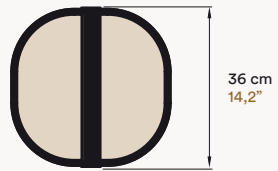

MATERIALS & COMPONENTS

Wood Veneer Shade

Metal Structure

Metal Back Plate

LIGHT SOURCE

220 - 240V
Integrated LED
Dimmable 0-10V

120 - 277V
Integrated LED
Dimmable 0-10V or TRIAC

ADA Compliant

FINISHES

WOOD VENEER

- 23 Natural White
- 22 Natural Beech
- 21 Natural Cherry

METAL

- BK-Matt Black
- GD-Gold
- IV-Ivory White



OMMA GD LED 23

ELI GUTIÉRREZ

KASA



THE CURIOUS LIGHT

Kasa is a bijou and rather curious table lamp designed by Eli Gutierrez. The lamp's rounded wood veneer panel has a slight conical shape, tapering inwards from its edge to a central point.

A metal mushroom-like appendage reflects light onto the panel, which in turn quietly illuminates the surrounding space. An angled metal arm connects the panel to a cylindrical marble base.

Kasa is a decorative lamp with two sides: one is somewhat playful in its demeanour; the other much more reflective.

The Kasa table lamp has an Ivory White interior wood veneer finish and a Natural Cherry exterior finish. The lamp has a Black Marquina Marble base, and metal finishes include Matt Black, Gold, and Ivory White.



KASA M BK 21-20

KASA TABLE

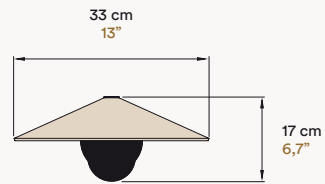
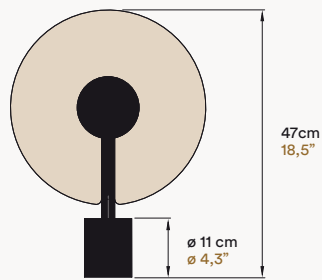

MATERIALS & COMPONENTS

Wood Veneer Shade

Metal Structure

Marble Foot

Electrical Cable with Dimming Switch 145 cm 57"

LIGHT SOURCE

220 - 240V
Bulb G9

120V
Bulb G9

FINISHES

WOOD VENEER

Interior

Exterior

○ 20 Ivory White with ● 21 Natural Cherry

MARBLE

● Black "Marquina" Marble

METAL

● BK-Matt Black ● GD-Gold

○ IV-Ivory White



KASA M BK 21-20

ESTELA



TEARS OF LIGHT

Designed by Mayice, Estela's new glistening vertical formation reminds us of tears of happiness or happy tears. In Estela, the light cascades through wood veneer encapsulated in borosilicate glass—the glass is hand-blown by master artisan Eduard Garuti. Despite their very different characteristics, these two materials mutually support each other. Through its wood and glass symbiosis, Estela is a distinctive lamp that creates uniquely enchanting spaces.

Estela's new vertical formation is available in small, medium, and large sizes. Direct light from a side opening can be manually arranged to illuminate a space according to the user's needs. Estela's new vertical alignment is truly radiant and showcases the lamp's artistic merit. Up close, the natural imperfections in the hand-blown glass simply augment the lamp's warmth, charm and elegance.

ESTE SV 90 LED 20



ESTELA SUSPENSION

SMALL

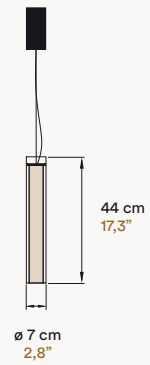

MEDIUM

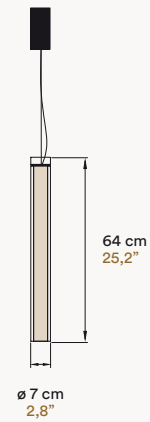

LARGE

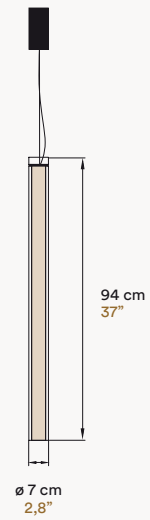

MATERIALS & COMPONENTS

Wood Veneer Shade

Hand Blown Glass: Borosilicate





Metal Canopy

Coaxial Cable: 2,5 m drop 8 ft drop

Steel Cable: 2,5 m drop 8 ft drop

FINISHES

WOOD VENEER

- | | |
|---|--|
|  20 Ivory White |  33 Pale Rose |
|  21 Natural Cherry |  34 Sea Blue |
|  22 Natural Beech | |

LIGHT SOURCE

220 - 240V

Integrated LED

Dimmable 0-10V, Bluetooth or DALI



120 - 277V

Integrated LED

Dimmable 0-10V or TRIAC

ESTELA SV 60 & 40 LED 20



ESTE SV 60 & 40 LED 33



DUNE



THE DEEP SIGH

The award-winning Dune, imaginatively designed by Mayice, is now available in a striking vertical version. When we see Dune in its new vertical form, it reminds us of the feeling of letting out a deep sigh—that ‘kicking off our shoes’ and relaxing moment.

Hand-blown by master artisan Eduard Garuti, Dune’s characteristic bulb-shaped centre is especially distinct. Encapsulating LZF’s wood veneer in glass, Dune in its vertical form is gloriously vivid and warm.

Extending LZF’s collection of unique pieces, Dune is available in crystal, made by accomplished master craftsmen and women.

Dune is available as a Vertical and Horizontal light, with a number of wood veneer finishes: Ivory White, Natural Cherry, Natural Beech, Turquoise, Pale Rose, and Sea Blue.



DUNE SV120 LED 33

DUNE SUSPENSION

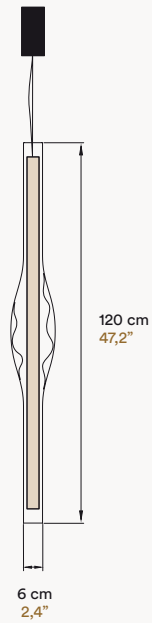
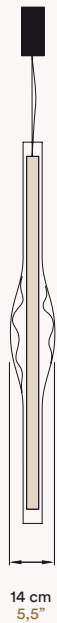

MATERIALS & COMPONENTS

Wood Veneer Shade

Hand Blown Glass: Borosilicate

Metal Canopy

Coaxial Cable: 2,5 m drop 8 ft drop

Steel Cable: 2,5 m drop 8 ft drop

LIGHT SOURCE

220 - 240V

Integrated LED

Dimmable 0-10V, Bluetooth or DALI

120 - 277V

Integrated LED

Dimmable 0-10V or TRIAC

FINISHES

WOOD VENEER

- | | |
|---------------------|----------------|
| ○ 20 Ivory White | ● 30 Turquoise |
| ● 21 Natural Cherry | ● 33 Pale Rose |
| ● 22 Natural Beech | ● 34 Sea Blue |

AWARDS



USA



USA



DUNE SV 120 LED 33

SUSHI



THE

EDOMAE

LIGHT

Sushi, a suspension lamp designed by Ray Power, captures the essence of the traditional Japanese dish (Edomae sushi) in wood veneer.

The unfussy, elongated lamp is wrapped in a narrow metal band—in the manner of rice wrapped in seaweed. As a lamp, Sushi reflects the Japanese aesthetic for simple, elegant, and functional designs made using wood.

In designing Sushi, Power focuses attention on the natural beauty of wood veneer.

The Sushi pendant lamp is available in all LZF wood veneer colours, and offers the possibility to combine two colours. The lamp's metallic finishes are matt black, matt nickel, or gold.



SUSH S GD 21

SUSHI SUSPENSION

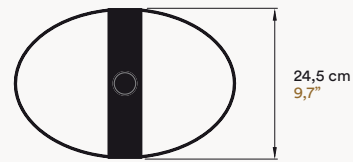
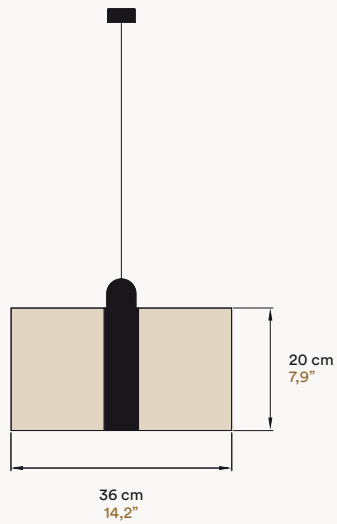

MATERIALS & COMPONENTS

Wood Veneer Shade

Metal Estructure

Metal Canopy

Electrical Cable: 2,5 m drop 8 ft drop

LIGHT SOURCE

220 - 240V

Bulb E27

120-277V

Bulb E26

FINISHES

WOOD VENEER

- | | |
|---------------------|----------------|
| ○ 20 Ivory White | ● 26 Red |
| ● 21 Natural Cherry | ● 28 Blue |
| ● 22 Natural Beech | ● 29 Grey |
| ● 24 Yellow | ● 33 Pale Rose |
| ● 25 Orange | ● 34 Sea Blue |

*Choose one or two colours for your finish.

METAL

- | | |
|------------------|-----------|
| ● BK-Matt Black | ● GD-Gold |
| ● NI-Matt Nickel | |



SUSH S BK 33-22

ISIDRO FERRER

BIRDY



THE

FLEDGLING LIGHT

Birdy is a new, smaller sibling of LZF's larger Big Bird. Created from the imagination of artist Isidro Ferrer, Birdy is made in collaboration with master artisan Manolo Martin.

Both inspired and inventive, the lamp is built with a traditional woodcarving technique used by Fallas artisans, known as vareta.

Like a young bird that has just fledged, Birdy is available in a horizontal or vertical configuration: in both forms, a frosted glass ball, a nectar of light, hangs from its beak.

Similar to its larger companions, Birdy hovers gracefully, with a sense of ease. An eye-catching sculpture, Birdy is testament to LZF's creative and technological mastery of wood and light.



BIRDY L S H LED 20



BIRDY LS H LED 20

BIRDY LIFE SIZE

VERTICAL

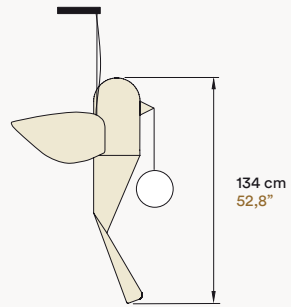
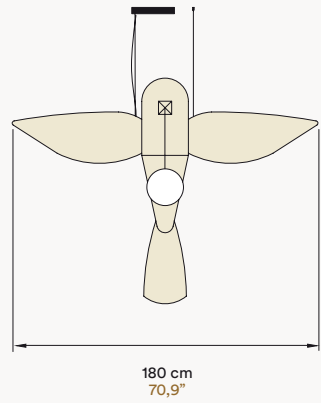

HORIZONTAL

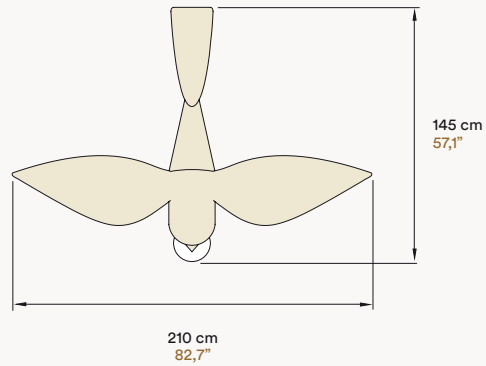
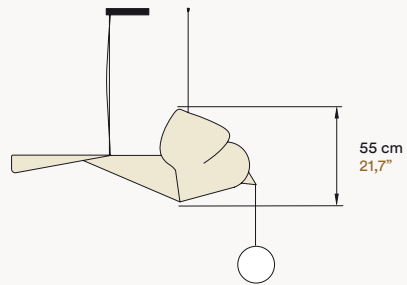

MATERIALS & COMPONENTS

Oak & Birch Wood

Wood Veneer Diffuser

Frosted Glass Ball

Metal Canopy

Steel Cables: 5 m drop 16,5 ft drop

Electrical Cables: 5 m drop 16,5 ft drop

LIGHT SOURCE

220 - 240V

Main Body: Integrated LED, Dimmable 0-10V

Glass Ball: Bulb E27

120 - 277V

Main Body: Integrated LED, Dimmable 0-10V & TRIAC

Glass Ball: Bulb E26

FINISHES

WOOD VENEER

○ 20 Ivory White



VERTICAL



HORIZONTAL



BIRDY L S V LED 20



BIRDY LS H LED 20

FINISHES



NATURAL TIMBER VENEER



20.
Ivory White
Off / On



21.
Natural Cherry
Off / On

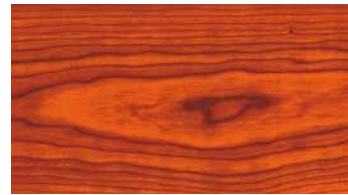

22.
Natural Beech
Off / On



24.
Yellow
Off / On

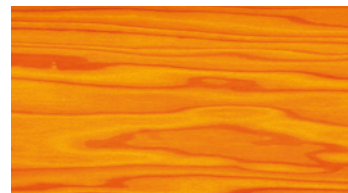

25.
Orange
Off / On

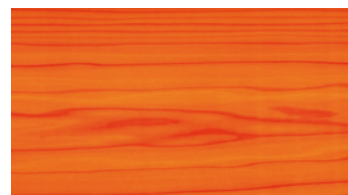

NATURAL TIMBER VENEER



26.
Red
Off / On



28.
Blue
Off / On

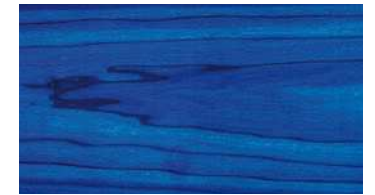

29.
Grey
Off / On



33.
Pale Rose
Off / On

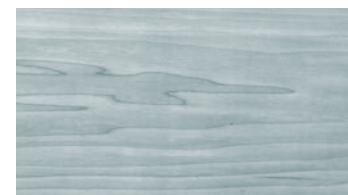

34.
Sea Blue
Off / On

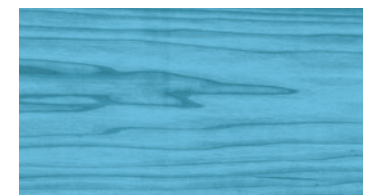

Please only use these reproductions as a guide.
Use LZF wood swatches to see the spectacular real effect of the illuminated veneers.
The dramatic effect of light passing through the wood veneer is the essence and hallmark of LZF.
This important feature would not be possible without the application of our patented process in treating the raw natural veneer: the Timberlite® system.



Timberlite®, the result of LZF's research & development and allows us to work with extremely flexible, yet very resistant veneer, which can take on many shapes without breaking.
In addition to all our veneers being FSC certified, thanks to the Timberlite® treatment, the wood used to fabricate our lamps maintains its natural qualities, adopting different nuances and hues over time.

NATURAL TIMBER VENEER

21 Natural
Cherry
Off



21 Natural
Cherry
2700k



21 Natural
Cherry
3000k



21 Natural
Cherry
4000k

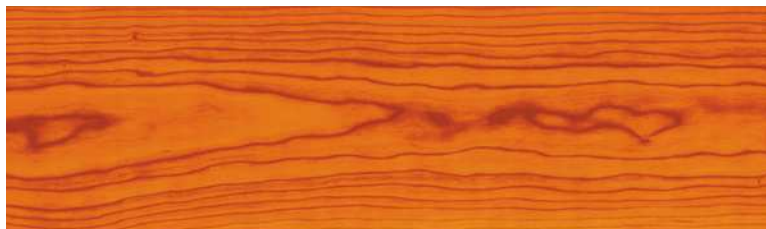

Choose your light temperature carefully, wood veneer colour can change radically depending on the colour temperature you use.

Recommended temperature LED for coloured LZF shades:
20- Ivory White (3000k-6400k)
21-Cherry, 22-Beech, 28-Blue, 29-Grey and 34 Sea Blue (4000k)
24-Yelow, 25-Orange, 26-Red and 33 Pale Rose (2700k-4000k)

METAL FINISHES

COLOUR METALLIC FINISH

BK
Matt
Black



IV
Matt
Ivory



NI
Matt
Nickel



GD
Gold



DESIGNERS

ELI GUTIÉRREZ



Eli Gutiérrez is a cosmopolitan designer, born in Valencia, Spain. After completing her studies in her home city, she moved to London to study a Master's in Product Design at the Royal College of Art. This step helped her to shape a clear and elegant vision for her own design language, and to hone a keen sense of materials, colours, and textures. Subsequent to this experience, Eli lived in Milan and Paris, where she collaborated with Patricia Urquiola, Philippe Starck, and India Mahdavi.

In 2016, Eli founded her own multidisciplinary design studio between Paris and Valencia. She defines her cosmopolitan and cross-cultural approach as that of a 'World Citizen': an explorer attentive to detail, and a traveller with a contemporary and incisive view on remodelling the traditional codes of our environment. Eli's designs feature unique, embedded stories, and are often expressed with an eloquent and fresh elegance.

Omma

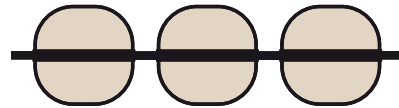

Kasa



MAYICE



AWARDS

- AD Campari New Talent Award 2021.
- NYCxDESIGN Awards Winners 2021. Dune H.
- Best of Year. Award 2020. Dune H.

Madrid-based Mayice Studio, a multidisciplinary product design and architecture practice, was established in 2013 by Imanol Calderón Elósegui and Marta Alonso Yebra. With a sharp focus on materials—respecting both history and functionality—each design by Mayice Studio is presented with its own inherent personality, and aims to reflect the soul of a material.

In much of Mayice Studio's work, we find an intelligent dialogue between craft and technology.

Glass is a central component of Mayice's work and the studio is especially captivated by its elementary principles of transparency, reflection, and refraction.

Mayice's designs for LZF demonstrate a respect for the environment, the authentic and the natural, the ethereal and the dreamlike.

Dune & Estela

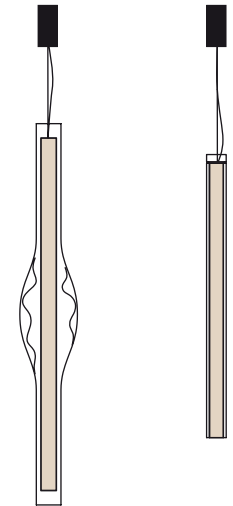

RAY POWER



AWARDS

- Casa Decor Award, 2019. Lola.
- Green Good Design Award, 2018. New Wave.
- Good Design Award, 2016. Swirl.
- Good Design Award, 2013. Escape.
- Good Design Award, 2009. Air.
- Design Plus Award, 2007. Link.
- Good Design Award, 2007. Link.

Irish-born designer Ray Power has collaborated with LZF Lamps since 1998. With an inventive approach to lighting design, he has created many of LZF's best known lights. Ray's Air (2008), Link (2007) and New Wave (2015) lamps for LZF were awarded the Red Dot, Chicago Good Design and Chicago Green Good Design awards respectively.

Most recently, his Swirl pendant was accorded a 2017 Special Mention by the German Design Council. Ray's work has been exhibited on the international stage: in Milan, Valencia, Dublin, Madrid and Tokyo.

His trademark style is based on geometry and he shows an inherent propensity to create stirring three-dimensional forms with flat materials.

Sushi

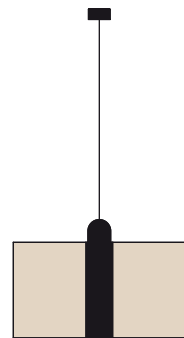

ISIDRO FERRER



AWARDS

- Good Design Award, 2021. Big Bird.
- Good Design Award, 2015. Smelly Fant.
- The National Illustration Award, 2006.
- The National Design Award, 2002.

From sketches made while travelling on the pages of his ever-present diary, to campaigns for government and in the field of graphic art, nothing is alien to Isidro Ferrer.

A one-time actor, he is now an acclaimed illustrator and graphic designer, and winner of the much sought-after Spanish National Design Award in 2002.

Isidro is a fervent illustrator and designer, having created LZF's cast of 'Funny Farm' characters, as well as the life-size Big Bird, Birdy, Smelly Fant, and Walking Fish. His ability to devour what is seen and then create art, means Isidro may in fact have one of the largest appetites on the planet.

Birdy

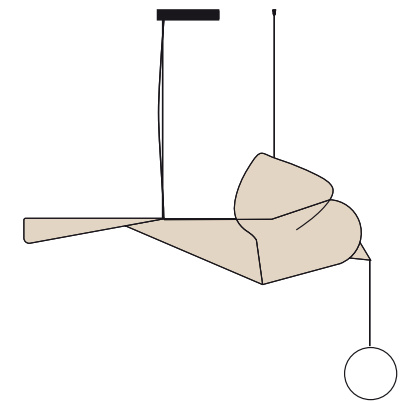

CREDITS

MARIVÍ CALVO

Project Director

KLUNDERBIE

Principal Photographers

EMILIO LEKUONA

Vertical Birdy & Details Photographer

SANTIAGO RELANZÓN

Horizontal Birdy's & Details Photographer

LZF / MIRIAM CASTELLANO

Graphic Design

GERARD McGUICKIN

Writer

XAVIER CORBERÓ HOUSE

Location

Special thank's to Gandia Blasco

LOGIK GRAPHICS

Printer

©Luziferlamps, S.L. Valencia. Spain. 2022.
All rights reserved.



KLUNDERBIE

Photographers



lzf-lamps.com